

SUBMITTAL DATA

BUCKLEY EQUIPMENT SUPPORTS

MODELS ES-100, ES-200 & ES-300

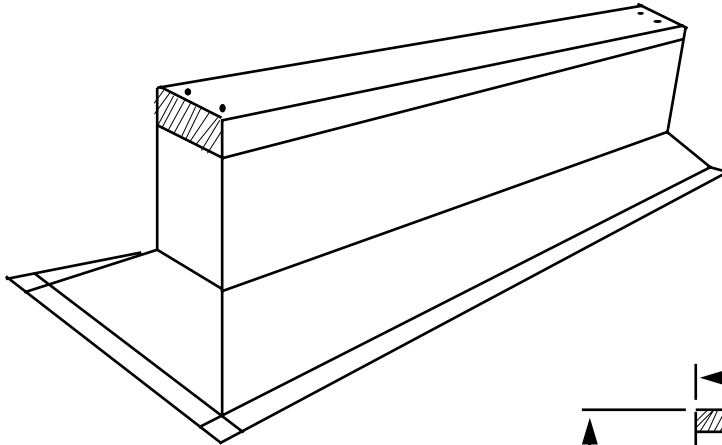

Specification Notes:

- 18 Gauge Galvanized Steel
- Continuous welded seams
- Widths 4", 6" & 8" with Wood Nailer as standard
- Heights: 8", 12", 16" & 24"
- Length: 12ft in one section with joiners for longer lengths
- Flashing cap standard

Options

- Neoprene Gasket
- One or two way pitch
- Special reinforcement for extra heavy loading
- Aluminum Construction .063
- Heavier Gauges

Standard industry tolerances apply.
Specifications are subject to change without notice.

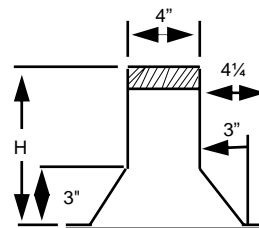

MODEL ES-300-4

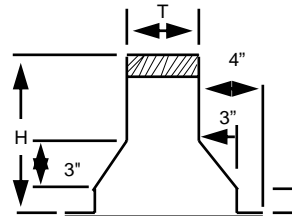
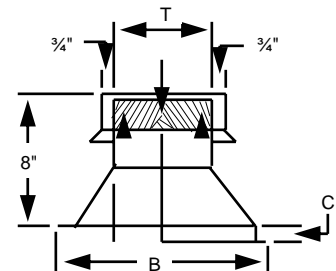

MODEL ES-200

Raised Cant available in all styles
Note: Specify measurement

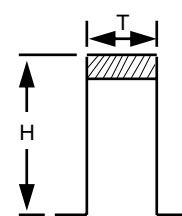

MODEL ES-100

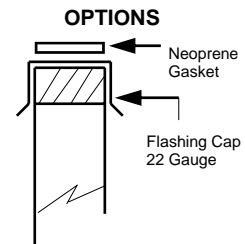
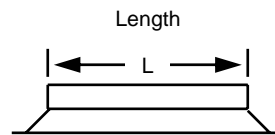

To maintain Buckley's policy of continuous improvement, we reserve the right to change prices, specifications, ratings or dimensions without notice or obligation. **Manufactured by Sheet Metal Union Local 17.**

MANUFACTURED BY: Buckley Associates, Inc. HANOVER, MA

Visit us on the World Wide Web at: <http://www.buckleyonline.com>

